

Final Report



2010/2011

European Project Semester at ISEP

Name: Fátima Leal N. 1080560

Name: Mihály Varga N. 1101675

Name: Marc Ribas N. 1101694

Name: Mateusz Małkowski N. 1101687

Index

Abstract	3
Glossary	3
Introduction	4
State of the Art	6
Type of humidifiers	6
Control	7
Web Interface	7
List of Material	8
Project Development	9
Architecture	9
Functionalities and Developments	10
Humidifier	10
Tank	12
Control	13
Construction program for the Arduino	13
Electrical circuit	20
Container	22
Web interface	23
Marketing Plan	23
Situational analysis (Market analysis)	24
Marketing Strategy and Objectives, tactical Marketing Programs	26
Marketing Mix	27
Conclusions	30
Future Developments	31
Bibliography	31

Abstract

How can the international team make humidifier for data center? How can they do it without any knowledge about it? They are Erasmus students from Spain, Portugal, Poland and Hungary. They have had a lot of problems with this project. Starting from communication and English language and finishing on technical troubles. In this report you can find information how they was working during 4 month. Do they make working solution?

Glossary

Arduino is an open-source electronics prototyping platform based on flexible, easy-to-use hardware and software. It's intended for artists, designers, hobbyists, and anyone interested in creating interactive objects or environments.

Air compressor is a device that converts power into kinetic energy by pressurizing and compressing air, which is then released in quick bursts.

Java is a programming language and computing platform. It is the underlying technology that powers state-of-the-art programs including utilities, games, and business applications.

Microcontroller is a computer-on-chip containing a processor, memory and peripheral input / output.

Notepad++ is a simple text editor for Microsoft Windows.

PLC is an programmable logic controller (PLC) or programmable controller that is a digital device used for automation of electromechanical processes.

Spray nozzle is a precision device that facilitates dispersion of liquid into a spray. Nozzles are used for three purposes: to distribute a liquid over an area, to increase liquid surface area, and create impact force on a solid surface.

SWOT analysis is a strategic planning method used to evaluate the **Strengths**, **Weaknesses**, **Opportunities**, and **Threats** involved in a project or in a business venture.

Tomcat is a Java Servlet container and web server from the Jakarta project of the Apache software foundation.

Introduction

Within the European Project Semester at ISEP, it was proposed to build a humidifier with a Web interface. Thus, this report describes the initial phases of construction of the humidifier.

This report is structured in six chapters. The first chapter is the introduction and presents the problem, the motivation, the objectives, the expected results and the project work plan. The second chapter is the state of the art that describes the options for the construction of all the parts of the humidifier and our choices. The third chapter is the project development and presents the project architecture, the modules, the functionalities and the tests. The fourth chapter is desolved a marketing plan to our product. In this marketing plan is included SWOT and market analysis. The fifth chapter is the conclusion. In this chapter we will describe what we learned with this project, the difficulties encountered and how to overcome them. Finally, in the sixth chapter, the bibliography, we list the references of all sources of information used.

This project will have as its main motivation the confrontation with real life and teamwork. We also have a great opportunity, not only to put into practice the knowledge acquired, but also to learn new things.

Every week we split up with supervisors in project meeting where we exposed our doubts and we reported the development of the project.

During these months we are confronted with different people with different ideas and different ways of working. In the first month, we are faced with many difficulties with communication and teamwork. With each passing day, these difficulties were overcome because we improved the form of communicating and began to know each other better improving equally the teamwork.

The difficulties were overcome because everyone had the same goal.

The goal is to develop a humidifier with a Web interface for a server room of 80 m³.

The final product must:

- Maintain of a relative humidity between 40 % and 70 % (+- 5);
- Distribute the generation of water vapour within the room;
- Have two days of autonomy;
- Be placed on the floor of the room;
- Include water and humidity alarms;

- Have an on-off switch;
- Be compliant with the EU Directives 2006/42/CE 2006-05-17 and 2006/95/CE 2006-12-12;
- Have a composite material structure to hold the control unit and the water container;
- Include a life-cycle analysis.

We have as available parameters:

- Air flow;
- Incoming air temperature;
- Chiller input temperature;
- Budget limit: 900 €.

Knowing all the requirements specified by the customer, initially, we divided the work into four black boxes designated as humidifier, tank, control and Web interface. On some of project meetings we draw a graph demonstrated in figure 2 in the boardroom.

For a better organization the work, we developed a Gantt Chart and divided the tasks between us. Once built this Gantt Chart we try to follow it but sometimes failing to respect it.

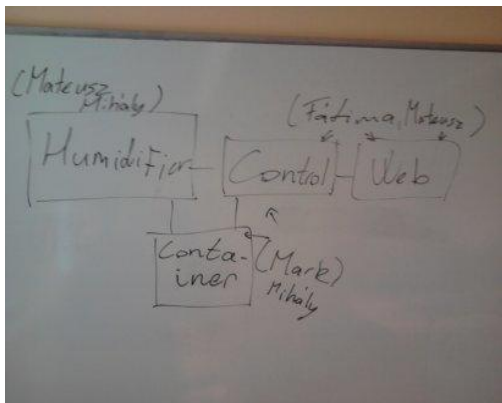

Figure 1

	Weeks															
Tasks	1(9)	2(10)	3(11)	4(12)	5(13)	6(14)	7(15)	8(16)	9(17)	10(18)	11(19)	12(20)	13(21)	14(22)	15(23)	16(24)
Searching the information			■	■	■				■	■						
choose the best idea					■	■			■	■						
interim report						■	■									
buy components							■	■	■	■						
create the black boxes									■	■	■	■	■			
connect the black boxes											■	■	■	■		
test													■	■	■	
correct mistake																■
final report and presentation																
	() -week of the year															

Figure 2

State of the Art

A humidifier is a household appliance that increases humidity (moisture) in a single room or in the entire house. In this case the humidifier will go to moisten a data center with a view to a better functioning.

Type of humidifiers

- **Steam humidifier**

Working method: It makes the vapor by heating the water above its boiling point, then distribute this steam in the room.

Advantage: fast, can make a big amount of vapor

Disadvantage: need lot of energy, heating the room

- **Fan humidifier**

Working method: It contains a pot with water and a filter in it. That filter soak up the water. Above the filter there is a fan, what is moving the air of the room through the wet filter and the water vaporize in natural way.

Advantage: made from simple parts → less failure possibilities, not need complex control

Disadvantage: slow, also move the air too

- **High water pressure:**

Working method: pressure pump supply water to the nozzles at between 50 bar - 70 bar. The nozzles are made for ceramic, opening 0,2 mm - 0,5 mm.

Advantage: no algae – high pressure, high performance, quiet work,

Disadvantage: high cost

- **Ultrasounds method:**

Ultrasounds are made by piezoelectric cell. The sounds make water trembling. It makes very small drops of water.

Advantage: quiet work, very small drops

Disadvantage: algae, low performance-high energy consumption

- **Compress air method**

Compress air is mix with water in special nozzle (pressure about 2 bar). Nozzle distribute water

Advantage: quiet work – if we use fridge compressor, quite cheap, quite simple

Disadvantage: algae

Control

For control the humidifier we found two solutions:



- ✓ Micocrontroller (Arduino)

Figure 3

- ✓ PLC



Figure 4

Microcontrollers are typically used in automation and control products and peripherals, as systems of automotive engine control, remote controls, residential and office machines, toys, surveillance systems. PLCs are based on microcontollers which allows solutions far economic. The current can be networked, often with private protocols of each manufacturer. It is increasingly common to use the Ethernet for connecting computers and PLC.

The final decision is to use the microcontroller insired in a small aplication called arduino. For this decision we thought in aplications and the price. The mainly point was the price because a Arduino war cheaper than PLC.

Web Interface

The web interface was developed with Java. The language derives much of its syntax from C and C++ but has a simpler object model and fewer low-level facilities. Java is currently one of the most popular programming languages in use, and is widely used from application software to web applications. For the interconnection of various parts of the Web interface we will use the following software:

- ✓ Tomcat
- ✓ MySQL
- ✓ Notepad ++



Figure 5

List of Material

After the research materials necessary for construction of the humidifier compiled a list of materials to buy:

All prices include IVA but not shopping costs

Product	Shop	Price
Compressor	Manutan	300,12 €
Nozzle	Lechler	100,00 €
Arduino Duemilanove	Inmotion	17,50 €
Arduino Ethernet Shield	Inmotion	30,00 €
Arduino box	Inmotion	9,90 €
Power Supply – 220V/12 V	Inmotion	12,95 €
3 Water sensor	Rsonline	3*8,97 €
Relay	Rsonline	2,40 €
Water Pump	Aquário Virgínia	21,00 €
Electrovalvue	ASCO Numatics FLUIDOCONTROL, S.A.	31,00 €
2 Reservoirs and other tools	Jumbo and Leroy Merlin	42,36 €
1 USB cable	Inmotion	4,25 €
Humidity sensor	Inmotion	13,75 €
3 Resistors	ISEP	-----
3 Leds	ISEP	-----
1 Transistor	ISEP	-----
Bread Board	ISEP	-----
Tubes	ISEP	----
Tranformer 220VAC/24 VAC	ISEP	----
Graetz Bridge	ISEP	----
1 Capacitor	ISEP	----
Total		612,14 €

Table 1

Without ISEP material the product cost **612,14 €**.

Project Development

Architecture

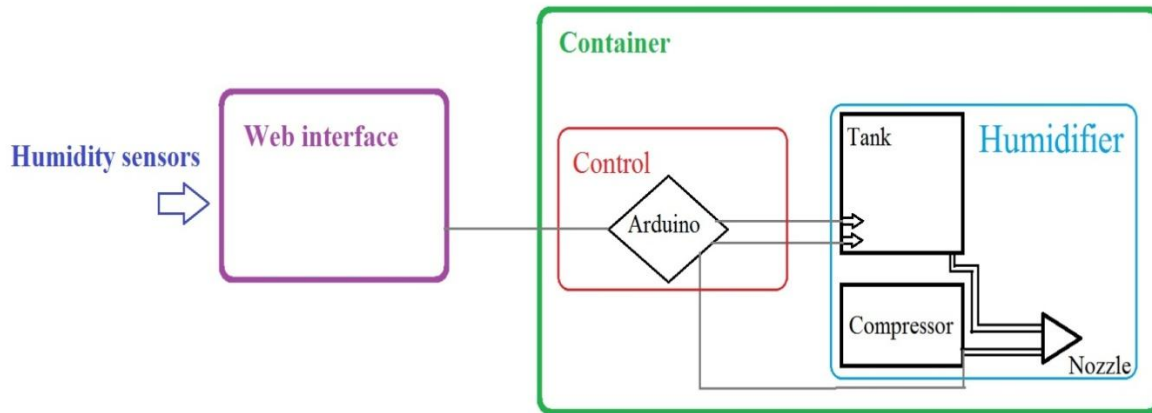

Figure 6

Modules

- Web interface
- Container
- Control
 - Control humidifier code
 - Control water tank code
 - Interconnection with Web interface
 - Electric circuit
- Humidifier
 - Compressor
 - Nozzle
 - Water tank



Figure 7

Functionalities and Developments

Humidifier

Datacenter humidity needs to be between 40 % - 70 %. For this we need of a humidifier and to decide how to do it. First, we had two diferent ideas:

- Compressed air humidifier;
- Fan with filter;

Faced with these two ideas and after some study and reflection on these ideas, we decided that the best way was the compressed air humidifier. However, the idea was changing. First we wanted to make own compressor and to use fridge compressor because it was very interesting and we could learn more things. We found working solution on the internet. It was the cheapest option and the more quite but we aren't sure it could work all the time and we weren't sure off air pressure. In the

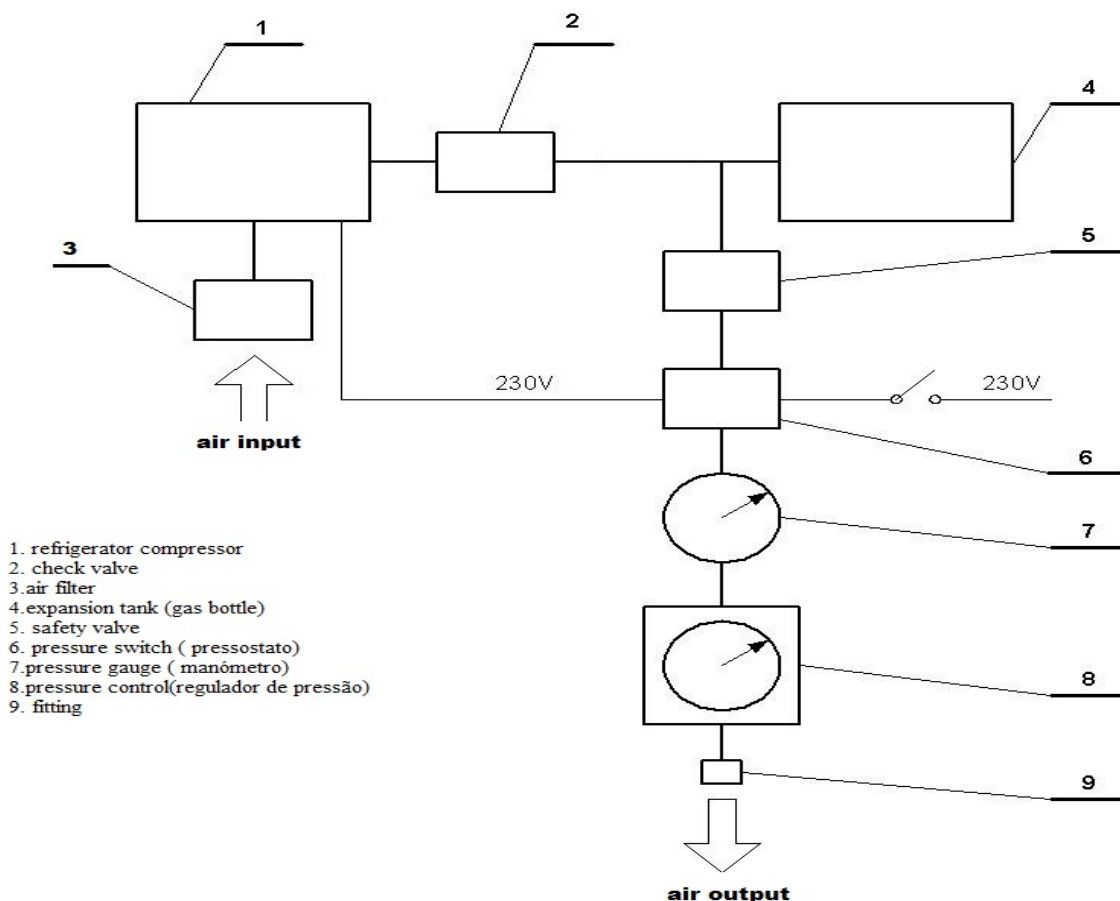

Figure 8

figure 8 is the graphic that presents how we wanted to make it.

After that we decided to buy the complete compressor in the shop. This way was easier and we had more sure that the final product would work. It is the most expensive part in our project. The compressor is demonstrated in figure 9 and it have the following characteristics:

- **Producer:** ABAC
- **Name:** Vinto 2002
- **Volt:** 230/240
- **Watt:** 1100
- **Max pressure [bar]:** 8
- **Silent:** 66 dB
- **Capacity of the air tank [l]:** 6
- **Dimensions [mm]:** 440x420x220
- **Weight [kg]:** 16



Figure 9

The next decision was to choose the tool that will produce the moisture. For that the our choose was very important because all work depended this tool. This tool is called nozzle and joins the air pressure with the liquid stored in a water tank. We use a nozzle with the following features:

Producer: Isofluido's Lechler Nozzle

Name: 136.330.35.16 *Q: [l/h]* 1,2 (4bar)



Figure 10

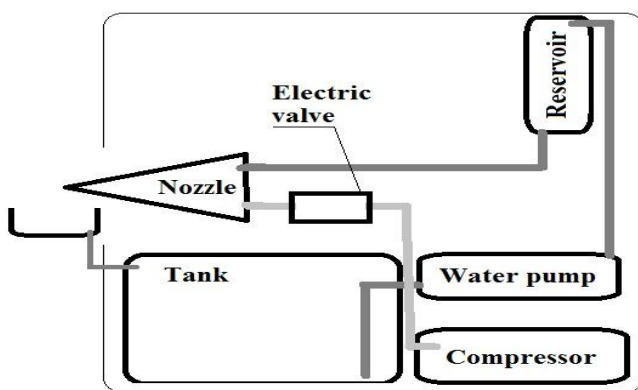

We bought the pump because we wanted to supply water to nozzle by the small container as shown in figure 11. The pressure will be controlled by a electrovalve.

Figure 11

With this solution we have many problems. The water from small tank go very quickly for nozzle and the water never stopped. A water valve could resolve this problem but we found another and efficient solution represented in figure 12:

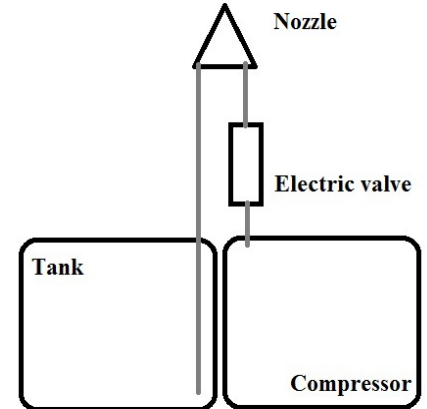

Figure 12

In this case we don't need any pump and any small container. The air presser is enough to suck water from the box and we don't have problem with drops of water. It is very simple and easy solution.

Tank



Figure 83

First we calculated that the 80m³ air how much water the air contains in the same temperature but in different percentage. After, we made it for the all temperature what occurred in the data center. Later by taking these numbers into a table we could easily calculate how many water we need to raise the hummidity from one point to the other. Unfortunately the datacenters measurements has not enough changes and we could not make tests in the room, so we couldn't calculate the exact amount what we need for 2 days. Than we chose

the tank to be enough for the worst case for two days.

For 80m ³ Relativ humidity	19°C	20°C	21°C	22°C	23°C	24°C	25°C
10%	126,4	136	145,6	155,2	164,8	174,4	184
20%	252,8	272	291,2	310,4	329,6	348,8	368
30%	379,2	408	436,8	465,6	494,4	523,2	552
40%	505,6	544	582,4	620,8	659,2	697,6	736
50%	632	680	728	776	824	872	920
60%	758,4	816	873,6	931,2	988,8	1046,4	1104
70%	884,8	952	1019,2	1086,4	1153,6	1220,8	1288
80%	1011,2	1088	1164,8	1241,6	1318,4	1395,2	1472
90%	1137,6	1224	1310,4	1396,8	1483,2	1569,6	1656
100%	1264	1360	1456	1552	1648	1744	1848

Figure 14

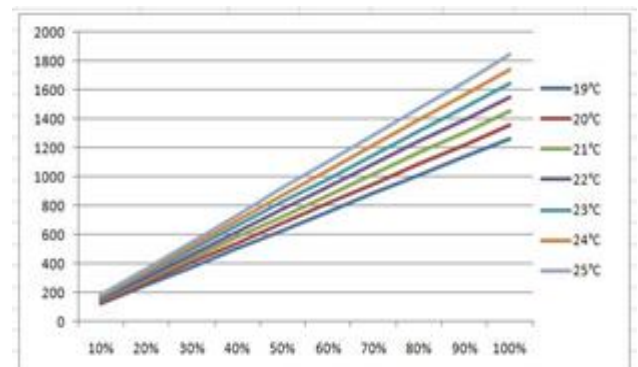

Figure 15

Control

As almost all of equipment our humidifier will have a control. The control was divided into several parts:

1. Water level (Tank)
2. Humidity control
3. Local humidity sensor
4. Internet connection

As previously mentioned, the controls will be done using an arduino. The program to control the arduino was conducted with the appropriate software for the Arduino.

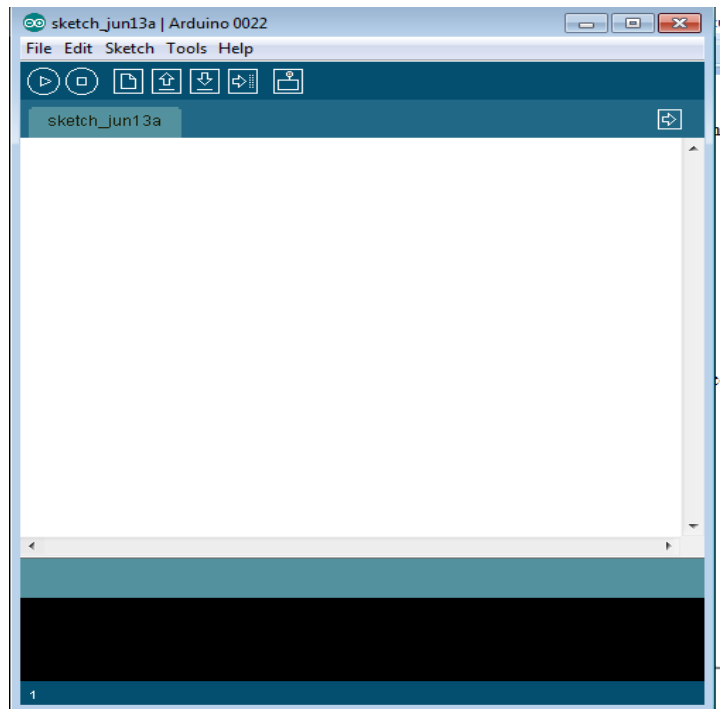

Figure 16

Throughout the construction of the program appeared new aspects that were needed for the success of the final product like:

- 5- Send an email with information on water level
- 6- Check the date and time

Construction program for the Arduino

At the beginning we were a little lost because we did not know how to begin. As a first step we build a small diagram that interconnected all parts of the code as shown in the following figure that was been improved on over time:

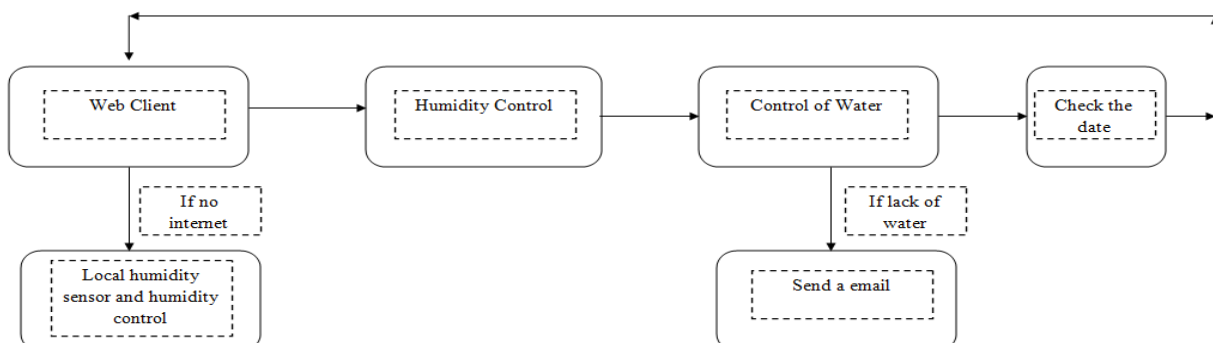

Figure 17

Looking at the diagram we knew that had many aspects to improve and this diagram simply organized way of thinking for building the program. The next step was to build a flowchart.

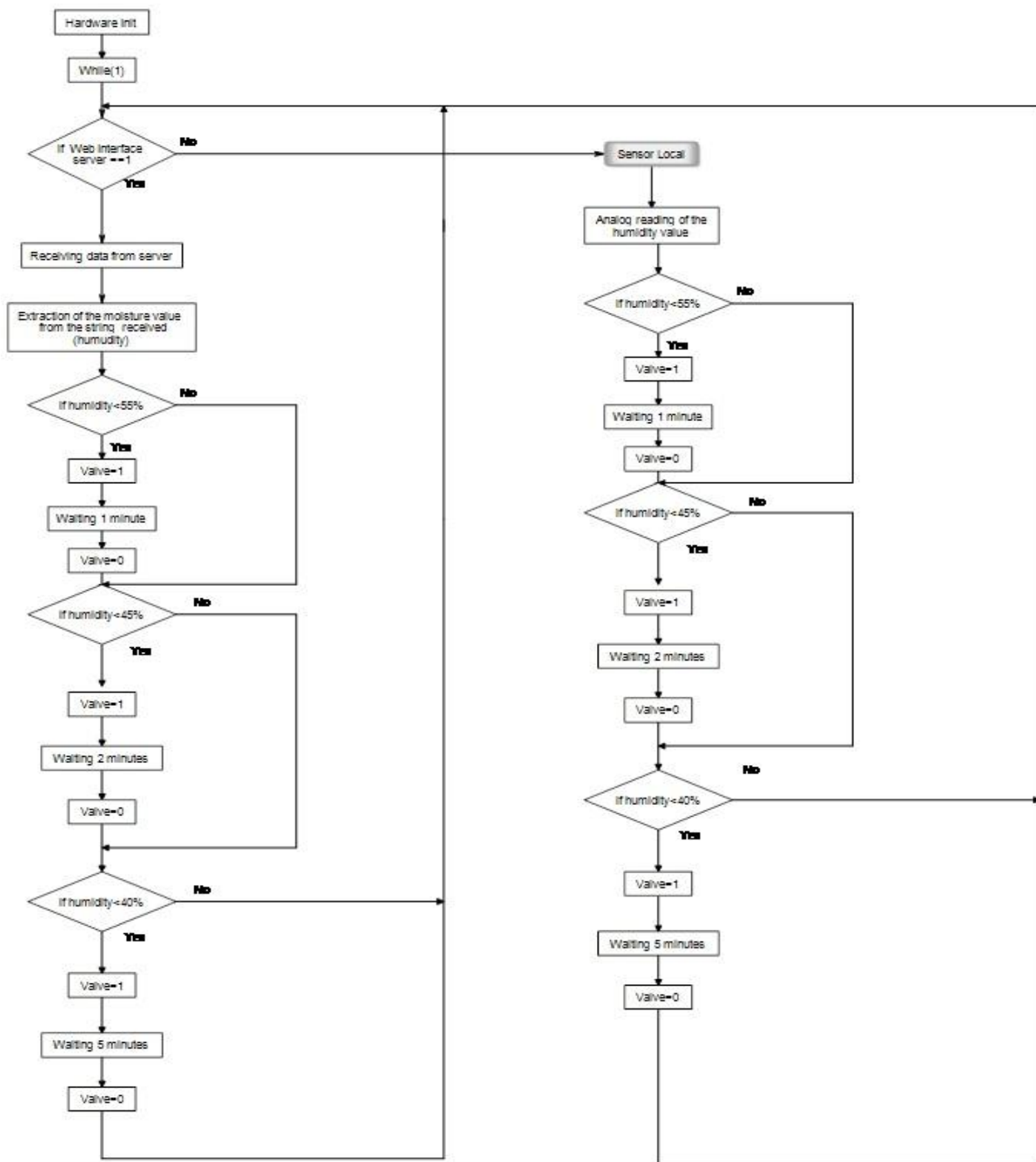

Figure 18

The flowchart of figure 17 explain the way that we will control the humidity. With internet working without problems, Arduino receive the answer of the server. After that, we extrated the humidity value and proceed to humidity control. For this and as the humidity has to be between the values 40% and 70%, for the control we made a medium in which our reference value will be 55%. If the minimum value of moisture from eight humidity sensors of data center is less than 55%, our humidifier will humidify during 1 minute. If this value is less than 45%, the humidifier will work during 2 minutes. Finally, if the humidity is less than 40%, the humidifier will work 5 minutes. Without internet connection the program will receive the values from sensor local and the humidity control will be the same. However, with compressor caracheteristics this control not be possible because compressor works two minutes and half and stop seven minutes and half. With this situation we will modify the code as we will show later in construction of code for Arduino.

Other part of the program will be the control water in the tank. This part contain two water level sensors that will give the information of lack of water and the empty tank to Arduino. When the tank is empty will be sent a email with this information.



Figure 20

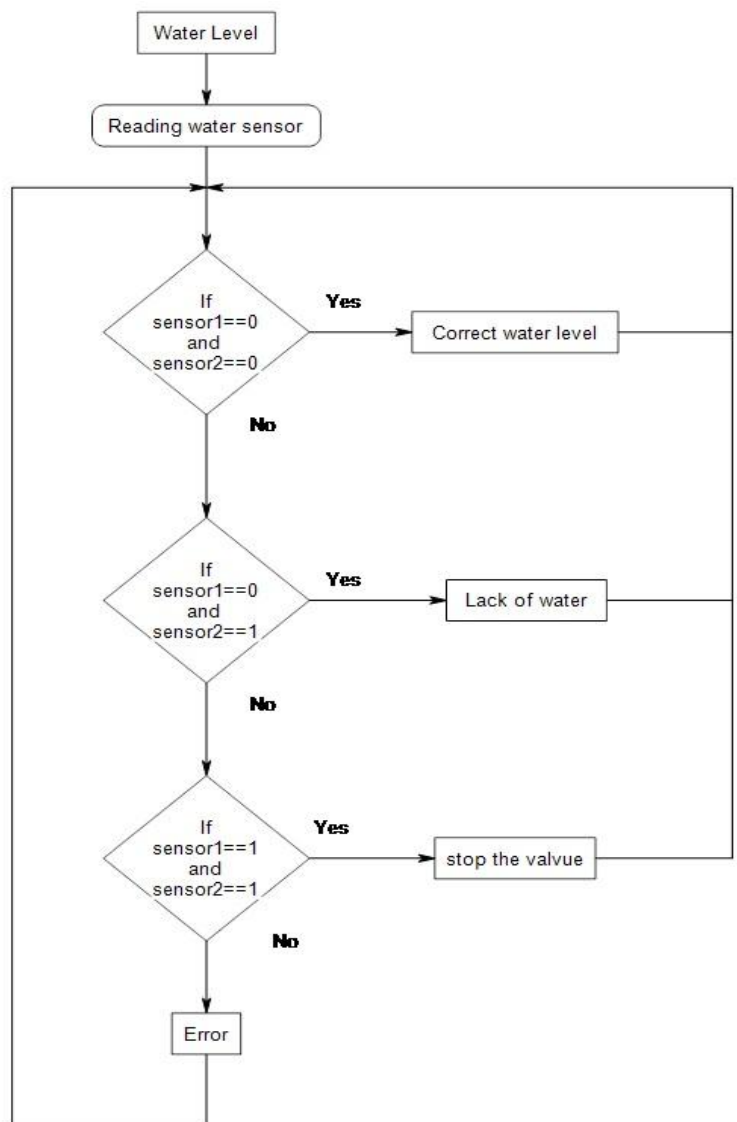

Figure 19

1- Code of Water level (Tank)

This is code of water level. The function `digitalRead()` read the digital value of sensors and after that the digital value is tested inside the 'ifs' as flowchart demonstrated. When the result is `sensorvalue1 = 1` and `sensorvalue2 = 2` the tank is empty and is sent a email with this information for to put water again and return to normal operation of the humidifier. The leds will gave the other information all the time.

```
void ControlWater()
{
  sensorvalue1=digitalRead(sensor1);
  sensorvalue2=digitalRead(sensor2);
  if (sensorvalue1==0 & sensorvalue2==0){
    Serial.println("Water level correct");
    digitalWrite(4, LOW);// leds of water off
    digitalWrite(5, LOW);
    delay(1000);}

  if( sensorvalue1==1 & sensorvalue2==0){
    Serial.println("Lack of water");
    digitalWrite(5, HIGH);// led of lack of water on
    digitalWrite(4, LOW);
    delay(1000);}

  if( sensorvalue1==0 & sensorvalue2==1){
    Serial.println("Error... Verify water level sensor!!!!");
    digitalWrite(4, LOW);
    digitalWrite(5, HIGH); // error
    delay(1000);}

  if(sensorvalue1==1 & sensorvalue2==1){
    sendEmail();// send a email
    digitalWrite(5, HIGH);// leds of water on
    digitalWrite(4, HIGH);
    Serial.println("All the sistem off ");
  }
}
```

Figure 21

2- Humidity control

This is code of humidity control. This function receives as parameter the minimum value of eight

```
void ControlHumidity(int min_value) {
  if( min_value < 55 ){
    digitalWrite(5, HIGH); // valvula activa
    Serial.println("Valvula activa");
    delay(30000); //ligada 30 segundos
    digitalWrite(5, LOW);
    Serial.println("Valvula desligada");
  }
  // min_value=100;
  delay(420000); // esperar sete minutos420000
  return;
}
```

Figure 22

overheating. The air will be controled with electric valve. Then, when we want the humidifier to work we put the valve on.

sensors read of data center. As we explained in the flowchart we focus on value 55% but with compressor caratheristics we changed the flowchart.

Then, for all work correctly the code is the following: If the `min_value` is less than 55% the humidifier works during 30 seconds. An then, the compressor stop during 7 minutes for to prevent

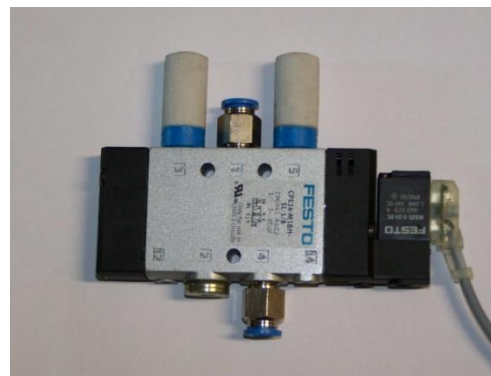

Figure 23

3- Local humidity sensor

This is the code of local sensor. If we do not have internet will use the value of local sensor. In this function is called user function HumidityControl the same way for control of humidity. AnalogRead

```
void sensor_local()
{
  local_sensor = analogRead(analogPin)/ 10.23;
  Serial.println(local_sensor);
  if ( min_value>local_sensor )
  min_value = local_sensor;
  HumidityControl(min_value);
}
```

Figure 24

function fetches the analog sensor and after that we have to split 10.23 for obtain the percentage.

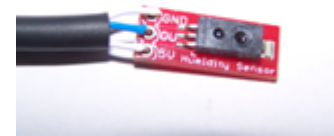

Figure 25

4- Internet connection

```
void OpenConnectionTomcat(){
  Serial.println("open connection to Tomcat server");
  // start the Ethernet connection:
  // give the Ethernet shield a second to initialize:
  delay(5000);
  while (!clientTomcat.connect()) {
    Serial.println("trying to connected");
    sensor_local();
    delay(500);
  }
}
```

Figure 26

This part initialize the connection with Web server. When the internet doesn't work the clientTomcat will go always trying to connect.

When the connection has success the server will send all the information that we want. For that, we have to ask and it is that clientTomcat.println (...) do in program, send the GET to server. After that we receive all the information. With the success of this operation we proceeded to extraction of the string value of the moisture received in order to do the control of moisture.

```
void getDataTomcat(){
  for(int contador = 0; contador < (max_length + 1) ; contador++) {
    if (!clientTomcat.connected()) OpenConnectionTomcat();
    if (clientTomcat.connected()) {
      switch(contador) {
        case 0:
          query = "GET /eps/servlet/GetServerDate HTTP/1.0";
          break;
        default:
          query = QUERY1;
          query.concat(contador);
          query.concat(QUERY2);
          break;
      }
      clientTomcat.println(query);
      clientTomcat.println();
      Serial.println(contador);
      delay(5000);
      while(clientTomcat.available()) {
        c = clientTomcat.read();
        resposta.
      }
      .....|
    }
  }
}
```

Figure 27

5- Send an email with information on water level

This part initialize the connection with Email server. When connection fail the clientEmail will go always trying to connect. As we have two diferent servers we will have two diferents clients:

- ClientTomcat that comunicate with port 8080
- ClientEmail that comunicate with port 25

```
void OpenConnectionEmail(){
    Serial.println("open connection to Email server");
    // start the Ethernet connection:
    // give the Ethernet shield a second to initialize
    delay(5000);
    if (!clientEmail.connect()) {
        Serial.println("trying to connected");
        delay(500);
    }
}
```

Figure 28

```
void sendEmail(){
    if (!clientEmail.connected()) OpenConnectionEmail();
    if (clientEmail.connected()) {

        clientEmail.println("HELO mailserver.isepp.pt");
        delay(wait);
        clientEmail.println("AUTH LOGIN");
        delay(wait);
        clientEmail.println("MTA4MDU2MEBpc2VwLmlwcC5wdA==");
        delay(wait);
        clientEmail.println("TWFUVOJQUkc=");
        delay(wait);
        clientEmail.println("MAIL From:<1080560@isepp.pt>");
        delay(wait);

        clientEmail.println("RCPT To:<1080560@isepp.pt>");
        delay(wait);

        clientEmail.println("DATA");
        delay(wait);

        clientEmail.println("To: 1080560@isepp.pt");
        clientEmail.println("Subject: You Have Mail!!!");
        clientEmail.println("Please let me know it worked!!!");

        clientEmail.println(".");
        delay(wait);

        clientEmail.println("QUIT");
        delay(wait);
    }
}
```

Figure 29

For to send the email we had to follow the SMTP protocol. SMTP or Simple Mail Transfer Protocol is a Internet mail protocol. It is a TCP/IP protocol used to send e-mails. Mail servers often use SMTP to send e-mails and POP or IMAP to let clients download the e-mails. This protocols needs some commands as shown in figure 26. The login and password had to be converted for base64. The code of the picture was our first test for send email.

6- Check the date and time

Throughout the development program we saw that it was necessary to verify the date and time for

```
minuto = extractminuto(resultado);
int total= (hora*60)+minuto;
```

that the data is not outdated. For that, we extracted the real hour and hours of sensors and we converted everything in minutes for compare, giving a safety interval of two minutes.

Figure 30

7- Hardware init

```
void setup () {
    pinMode(2, INPUT); // watersensor1
    pinMode(7,INPUT); // watersensor2
    pinMode(6,OUTPUT); // relay-electrovalve
    pinMode(4,OUTPUT); // led for empty tan
    pinMode(3,OUTPUT); // led for net
    pinMode(5,OUTPUT); // led for lack of water
    // start the serial library:
    Serial.begin(9600);

    Ethernet.begin(mac, ip);
    Serial.println("initialising EthernetShield...");
}
```

The setup in Arduino is inicialising the hardware and configure the pins as inputs or outputs.

Figure 31

Interconnection all the parts

In the end we connected all the parts of the code. For a better organization we divided the code in several files. In the first time that we test all the program we had very problems in diferents aspects. After some tests and testing separately each part of code the end result was:

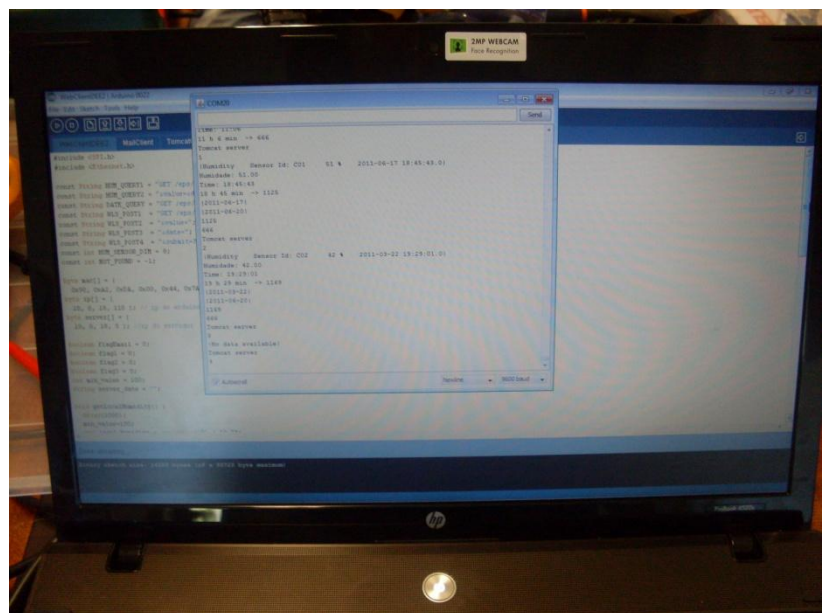

Figure 32

Electrical circuit

The last part of the construction of humidifier is the electrical circuit. For the construction of circuit we had to bear in mind some important aspects:

- Arduino Voltage – 12 V
- Inputs and Outputs Voltage of Arduino – 5 V
- Arduino intensity – 40 mA
- Valve Voltage – 24 V

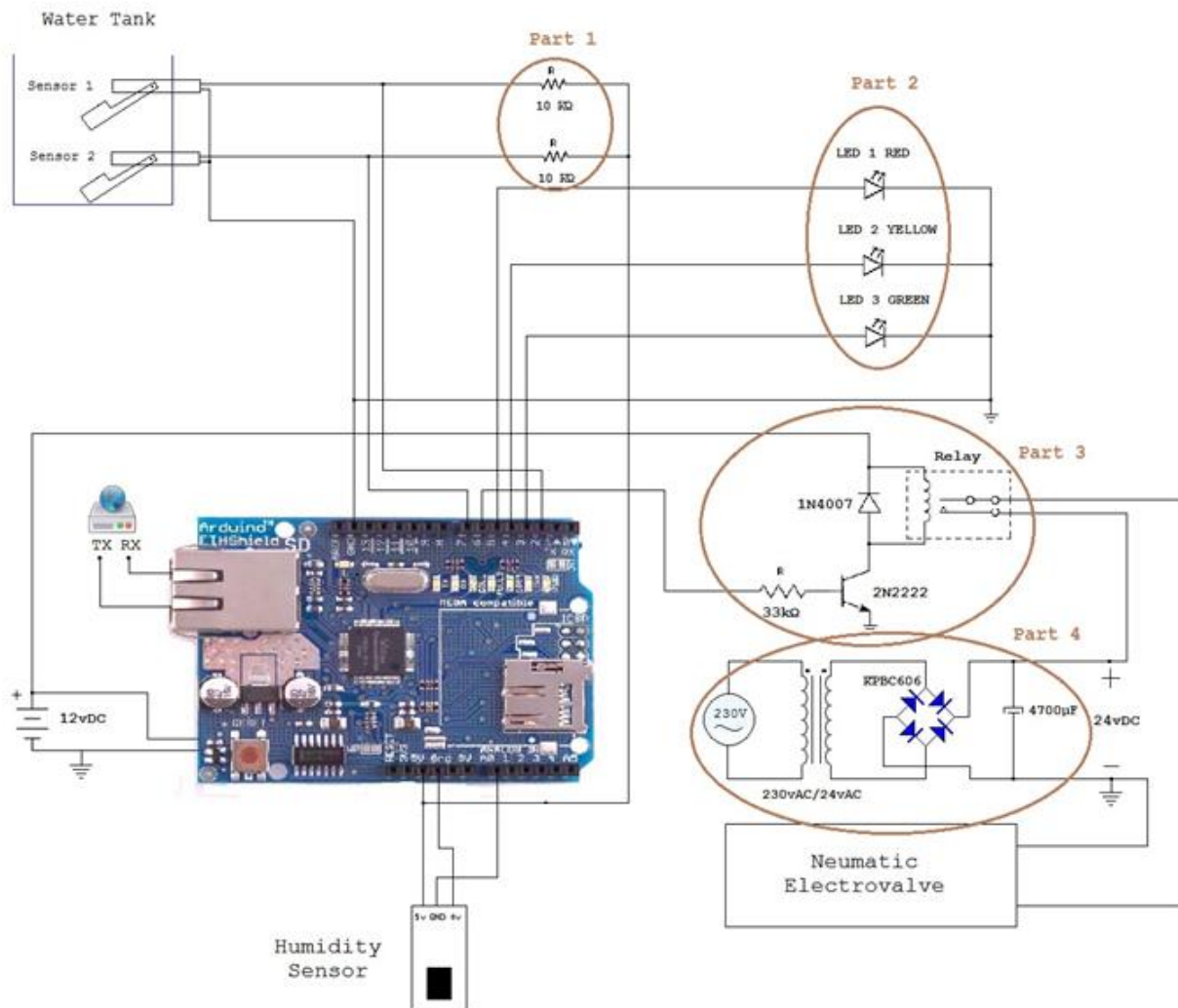

Figure 33

For to explain our circuit we divided in four parts.

Part 1

As the water sensors are like swiches we had to add two pullup resistors. When the sensor level is free (0), there is no connection between its two terminals, so, when the pin on the Arduino is connected to 5V (via the pull-up resistor) and read the pin, we get HIGH.

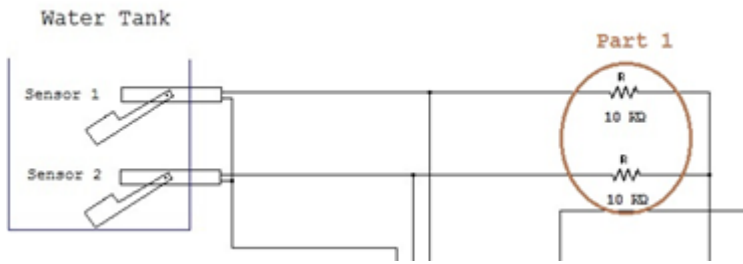

Figure 34

Part 2

To obtain some information on the operational status of the humidifier we put three LEDs that give us an information of three different things:

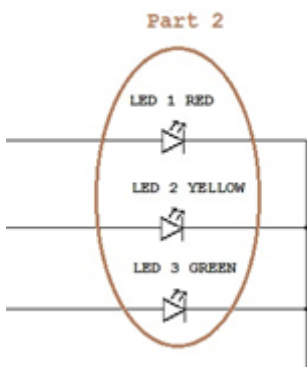

Figure 35

- LED 1 red – Empty tank
- LED 2 yellow – Lack of water
- LED 3 green – Internet is working



Figure 36

Part 3 and part 4

The third and fourth parts of the circuit are to control electricvalve. The part 4 of the circuit is for convert 230 vAC to 24 vDC because the valve needs 24 vDC. For this we used a transformer 230 V (AC) – 24 V (AC). Graetz bridge and condensator convert AC to DC. The part 3 of the circuit is for to control the electricvalve using the relay and doing the following calculations for calculate the resistor of 33 kΩ:

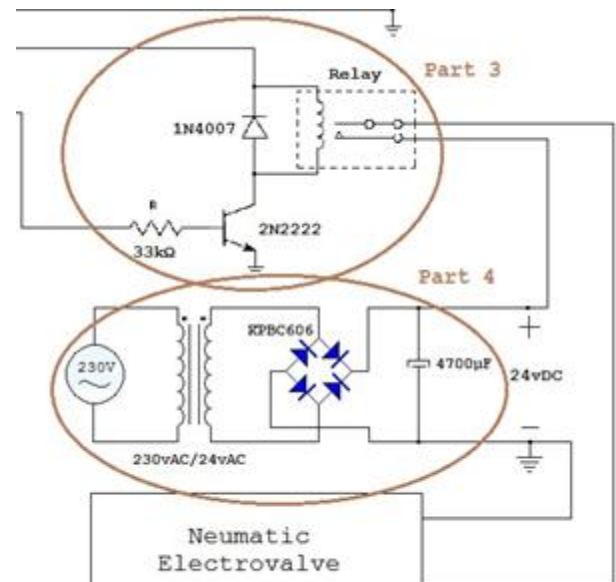

Figure 37

$$R_{coil} = 1 \text{ k}\Omega; V = 12 \text{ V}; I = \frac{12}{1000} = 12 \text{ mA} = I_c$$

Using the transistor 2N2222 – BC548 with $h_{fe} = 75$

$$h_{fe} = \frac{I_c}{I_b} \leftrightarrow I_b = \frac{I_c}{h_{fe}} = \frac{0.012}{75} = 0.16 \text{ mA}; \quad R = \frac{V_{arduino}}{I_b} = \frac{5}{0.00016} = 31250 \Omega$$

With this result the real resistor that was closer to the calculations was the 33 kΩ.

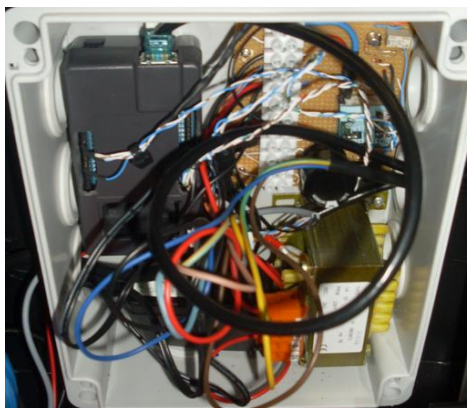

Figure 38

Container

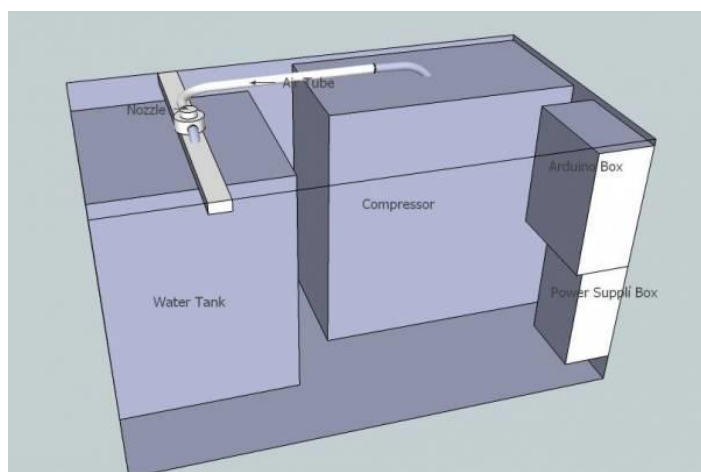

Figure 39

The container will contain all parts of our product. To get an idea of how we would get at bending of the project we did the following drawing. However, the design was modified over time because the ideas were changing in accordance the project development.

Now, with all the parts built and entered into the container, our project has the following design:

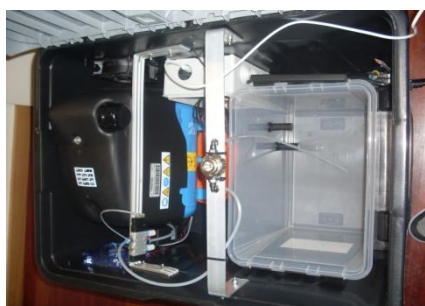

Figure 40



Figure 41



Figure 42

Web interface

The web interface will identify the sensors and life-cycle analysis of the humidity and temperature. The web interface is the tool that people use to see the development of moisture throughout the day. In a first contact with the language we develop a small and simple program to test the interconnection and compiling of software. We didn't create the Web interface, however, we learned some basics of Java language.

INSTITUTO SUPERIOR DE ENGENHARIA DO PORTO
European Project Semester Spring 2011



	Sensor Id	Value	Date
Temperature (°C)	<input type="text"/>	<input type="text"/>	<input type="text"/>
<input type="button" value="Get Temperature Data"/>			
Relative Humidity (%)	<input type="text"/>	<input type="text"/>	<input type="text"/>
<input type="button" value="Get Rel Humidity Data"/>			

©MBM, DEE 2011

Figure 43

Marketing Plan

With product done we will have to put it in the market. This marketing plan was developed with the purpose of market research, who would be the main customers, short-term goals and developing strategies that would help the product succeed in the market. This marketing plan includes a first analysis of the market. This part is the explicit description of the product and the main competitor. Then will state one of the most important parts of this plan marketing strategy and objectives, tactical marketing programs. In the last part of the marketing mix that studies the politics of the four p's. The lack of moisture in certain situations is very harmful to industrial equipment such as data centers but also for health. The thinking in these situations our product will be easily adapted to customer needs.

Situational analysis (Market analysis)

Current Products

Humidifier

A humidifier is a appliance that increases humidity. There are many kinds of humidifiers. In our case the product is a humidifier made exclusively for data centers with areas in a range of 80m² with 2 days being controlled through a web interface. However, depending on the application we will adapt the product with the desired control with or without a graphic interface(GUI).This product was developed with engineering methods.

Current Target Market

The market of data center humidifiers is very complicated. It is a small market because it don't have



Figure 44

many applications in daily life. In little applications the client buy the humidifier in any place without difficulty. In others applications, in applications with bigger dimension the buyer can't check the prices easily. The client have to call to company and make an appointment. We can reach more people if we make some instruction to how can they calculate the price for their need. In our case, there are few brands that sell all stuff for data centers. The main strategy of the sellers of humidifiers is the internet so do our will be. The internet is the firts place if someone want to search

for something, this is the fastest way to take the contact between the costumers and us. And last but not least this is the cheapest way to offer our products. But a shop has many advantages like there the customers can see what they want or can ask in live. So the further plan can be that to open a shop. Until we don't have shop we need to offer to deliver our product, but in this way we can reach more costumer.

In current target Portugal market there are some kinds of humidifier.

- For babies - <http://www.toysrus.pt/catalogue/ProductListBusqueda.php>
- The humidification experts (for larger applications as data centers) - <http://www.jshumidificadores.com.pt/?gclid=CKj-zMrS06gCFUIMfAodZgOJfA>
- Humidifiers for household

The first kind (humidifier for babies) can be found in shops specific for babies like toy stores, shops for children and sometimes in pharmacies because de humidification can be necessary for healthy. The second kind, maybe more like with our product, the humidification experts. This kind is used in industrial applications requiring humidity control how the data center. In this situation the market is

not very concentrate because is not necessary a big fabrication of humidifiers. The third and last kind, humidifiers for household, is very easy to be found. These can be found in electronics store or in simple supermarket. The brands are not portuguese be imported from other countries.

We can find data centers in:

- Port offices
- Business Centers
- Shopping Malls
- Universities
- Hospitals
- Banks
- Medium Companies

These places can be the our clients and potentially interested in our product.

Current Competitors

This moment one the competitor in Porto that we found is “JS HUMIDIFICADORES O ESPECIALISTA DA HUMIDIFICAÇÃO”. However exist many place where we can find humidifiers like:

- Supermarket
- Appliances shops
- Bricolage (DIY) shops
- Pharmacies

In Portugal we can find immense brands for all kinds of humidifiers:

- Solac HU 1050 (household)
- Chicco Humi Vap (babies)
- DeLonghi VH 300 (household)
- Nepronic SKE (industrial humidifier)
- JetSpray (industrial humidifier)
- Mistifier Plus (maintaining moisture in small areas of production, farm buildings or green-houses)
- Etc...

Our bigger weakness is the lack of market experience. We don't know how to communicate with customers. We don't know the real advantage of our solution against other companies, so we don't know what should say to the customers (if we found the way to communicate with them) to buy our products and services. However we have in our favor young and new ideas.

Marketing Strategy and Objectives, tactical Marketing Programs

We want to sell product only by the internet because we think that the best way to promotion our product. So, we will create internet shop for only one product. The web page will be in 4 languages: Polish, Portuguese, Spanish, English. We will pay for position in google. We must write instruction how to run and use humidifier and we will give out-door garanty for 1 year. Delivery by the courier. This is humidifier special for data centers. However we can adapt the humidifier for another application that the costumer want. We are developing a humidifier with Web interface and two days autonomy for a ISEP data center with 80 m2. This is an example that we can, not only developing any humidifier, but also to do the control and some software depending on the desired application. This is an important strategy because it can cause more customers are interested in our products for their businesses, offices or even homes. For our product we have the following objectives and strategy:

Objectives (“GOALS, which determine the focus”)

1. Increase brand recognition above 80% (client)
2. Maintain customer satisfaction rate above 90%
3. Launch new communications campaign to reach at least 80% of target
4. Achieve operational excellence in the internal processe of marketing, supplier, product development, logistics, social and environmental programs
5. Attract and retain talent

Strategy (Strategy is the production of plans to achieve goals)

1. Win at least two new markets
2. Increase the portfolio of products and services. Launch two new kinds of products in the year
3. Lower prices to attract buyers to track price sensitive
4. Being competitive
5. Young and innovative ideas

Tactical marketing programs

- Telemarketing promoting special discounts for new customers
- Participate in events for disclosure of the product (fairs)
- Increase customers' credit assets

Problems with lack of moisture ... EPS project is the solution.

Marketing Mix

The marketing mix or compound is formed by a set of controllable variables that influence the way consumers respond to the market. The compound is divided into four sections often called the “four Ps”. They are: **Product**, **Price**, **Place** (point of sale / distribution) and **Promotion**.

Product: Customer:

The product is a humidifier done for areas between 80 m². This humidifier is done with a silent compressor and nozzle that spreading humidity very effectively. The production is conducted in Instituto Superior de Engenharia do Porto by students of the European Semester Project. A young team with innovative ideas. The product was developed for data centers or industrial places that need moisture. How is industrial product, the design is not very relevant but the occupied space (round one square meter), the noise produced (66 dB) and autonomy (controlled as desired). The product contains the control with a Web interface to achieve the moisture that is desired as the autonomy that the client wishes. This is a new product with a new brand called “EPS” but it is innovative and dynamic, that is, easily adapts to all types of situations involving fata humidity.

Price: Cost:

The process of setting a price for the product, is for most companies a difficult process always thinking about the profit they can enjoy. Our definition of price was tied wondering if and only on the client. *Our price offers a good cost benefit ratio.* The our product have the following **prices**:

- With Web interface - 1199,99 € with 23% VAT included
- Without Web interface - 999,99 € with 23% VAT included

The price include VAT but not the shipping.

Discounts

However the customers who purchase 5 units of our product we offer a discount of 5%. The customers who purchase more than 10 units of our product we offer a discount of 10%. Deliveries in Portugal are free.

Forms and terms of payment

The forms of payment available are:

- Prepayment;
- Transfer;
- Check;
- Credit Card and Online Transfer;



Figure 45

For customers living outside of Portugal: (In these situations, the price will be adjusted according to exchange rates)

- Credit Card and Paypal.



Figure 46

The payment will be facilitated to customer preference.

Place: Convenience:



Figure 47

factive and convenient.

We want to sale it mainly on the internet and deliver our product freely in portugal and in world. We planning to sale the product only by ourselves on the internet, we don't want to use other tradeing companies. To do this we will create a website on the internet that can be accessed in four languages: Portuguese, Polish, Hungarian and Spanish and we can be visited for all people of world. This way the customer will have access easily to all product data, how to buy and the means of payment is fairly easy, ef-

Promotion: Communication:

For the sale of our product to take place we need to disclose it. The main medium is advertising. Not only do we get to each individual person but also the major industries that are likely to buy our product. Then, for to promote the product will take into account:



Figure 48

Portugal

- Advertising mail for industries or institutions that may purchase the product;
- Participation in fairs and commercial initiatives;
- Promotion of lectures in various parts of the country for better contact with potential customers by answering questions timely;
- Preparation of publicity material for distribution.

Rest of the world

- Advertising mail for industries or institutions that may purchase the product;
- Internet;
- Competitive discounts to large customers;
- Participation in fairs and commercial initiatives.

•



Figure 49

Conclusions

Throughout these months the job was teamwork. Initially we discussed the type of humidifier where we propose two options. The first option was using a humidifier cold type, through a nozzle, which should bring a compressor to supply compressed air and a water pump to provide water. The other option was to use a humidifier also cold, because hot type to use a humidifier too complicated and dangerous. The second option consists of a water tank which has a filter on top and a front fan, which means that there is an air circulation inside the tank and extract humidity outward. In the end we opted for the first option, because the shape of the humidity injected in the room is much faster and instant. The other discussion was to choose the type of control that we had to use because for the control we found two options viable. One option was to use a small PLC, since these devices are designed for the industry and it is very sturdy, its programming is also very easy, by GRAFCET. The other option was to use a microcontroller through arduino. The final decision was the price of the items, since the PLC and cost over 300 € and the Arduino costs about 60 €. The rest of material the choice was consensual and we just have few problems with the verification of specifications as with the electric valve. The construction of the humidifier was successful without any problems being easier to build than we had thought at the beginning because the nozzle was very efficient and we didn't need any pump or small reservoir. The opposite happened with the construction of the program that we've got a lot of problems and we need help sometimes. In the end the final product was successful and we overcome every problems.

We can conclude that was an interesting project and we had an opportunity to confront real life. The trickiest part was the choice of material and its specifications sometimes committing errors in which we shall acquire equipment that we do not need, or material not compatible with the specifications of the project.

The communication and teamwork was very difficult in beginning but we improving over time. During these months we discovered that the key to success “is doing what the other person does not want to do:

- Work long and hard
- Criticize and accept criticism
- Become involved”



Figure 50

We want to say thank you all supervisors that help for the our success in the EPS Project.

Future Developments

The next step in this humidifier should be system to remove water pollution. It could be chemical compound or UV lamp. The next developments could be finding the way to reduce a size and turn volume down. The next thing to do is container and structure. We don't have enough time to make it from composite material structure and water container. Maybe the size of container could be reduce. We can also add the pressure reducer to have the same pressure in the nozzle. For data center is better when container is higher than wider. It could make the same size of drops all time. The mail box where will be sent with information of water level of the humidifier tank should be consulted frequently. The compressor should be checked every 24 hours because the deposit will have to be purged. For this, will be sent an email with this information.

Bibliography

- [1] – Abac, Air Compressor, Available at <http://www.abac.co.uk/Compressors/Vento2002.htm>, Accessed in June 2011.
- [2] – Lecher, pneumatic nozzles, Available at http://pdf.directindustry.com/pdf/lechler/pneumatic-nozzles/Show/7037-33704-_3.html, Accessed in June 2011.
- [3] - Youtube, Silent air compressor, Available at <http://www.youtube.com/watch?v=wRu7ovacSuE&feature=relmfu>, Accessed in June 2011.
- [4] – Abac, Bricolandia, Available at <http://www.bricolandia.es/abac-vento-silent-om-200-compresor-de-aire-sin-aceite-om200/>, Accessed in June 2011.
- [5] – Otech, Humidifiers, Available at <http://www.otech.pl/nawilzanie.php>, Accessed in June 2011.
- [6] – Blogspot, Arduino, Available at <http://arduinatorj.blogspot.com/2010/10/botao-o-interruptor-momentaneo-e-um.html>, Accessed in May 2011.
- [7] – Lecher, Humidifiers, Available at http://www.lechlerusa.com/products/atomizing_1.asp, Accessed in May 2011.
- [8] – Marketing, Marketing, Available at <http://www.brandme.com.br/objetivos/>, Accessed in May 2011.
- [9] – Marketing, Marketing plan, Available at http://www.pmelink.pt/article/pmelink_public/EC/0,1655,1005_5057-3_41102--View_429,00.html, Accessed in May 2011
- [10] – Arduino, Arduino, Available at <http://www.arduino.cc/>, Accessed in May 2011

- [11] – Wikipedia, Programmable logic controller, Available at http://en.wikipedia.org/wiki/Programmable_logic_controller, Accessed in April 2011
- [12] – Wkipedia, Microcontroller, Available at <http://en.wikipedia.org/wiki/Microcontroller>, Accessed in April 2011.
- [13] – Wikipedia, Notepad, Available at http://en.wikipedia.org/wiki/Notepad_%28software%29, Accessed in April 2011.
- [14] – Java, Language, Available at http://www.java.com/en/download/faq/whatis_java.xml, Accessed in April 2011.
- [15] – Arduino, Available at <http://arduino.cc/en/Main/arduinoBoardUno>, Accessed in April 2011
- [16] – Arduino, EthernetShield, Available at <http://www.arduino.cc/en/Main/ArduinoEthernetShield>, Accessed in April 2011
- [17] – Manutan, Compressor, Available at <http://www.manutan.pt/compressores-portateis-compactos-compressor-silencioso-de-6-l-O-04679-750.html>, Accessed in March 2011
- [18] – Rsonline, Water sensor, Available at <http://pt.rs-online.com/web/search/searchBrowseAction.html?method=searchProducts&searchTerm=sensor+de+nivel+de+%C3%A1gua&x=0&y=0> , Accessed in March 2011.
- [19] – Inmotion, Humidity Sensor, Available at http://www.inmotion.pt/store/product_info.php?cPath=17_31&products_id=305, Accessed in March 2011.



Figure 51